











MASTER RANGE : INLINE SHOWER KITS (H2050 W1600xW1200)

| <u>PART LIST</u> | | <u>LENGTH (in mm)</u> | <u>QTY</u> | <u>MANUFACTURING</u> | <u>SUPPLIED WITH</u> |
|--------------------------|---|-----------------------|------------|---|---|
| MR FRAME |  | 2050 | 2 | Cut to size 2050mm Pre-Drill top & bottom to suit top & bottom sill | |
| MR SILL |  | 2500 | 2 | Cut to size | 8 x SS Screws with Wall Plugs & screw head covers. 6 x pop riverts (color to match frames) |
| MR WALL CHANNEL with LEG |  | 2050 | 2 | Slotted 3 holes in back side | 6 x SS Screws with Wall Plugs & Screw head covers. 10 x pop riverts (color to match frames) |
| MR POCKET FILLER |  | 700 | 2 | Cut to size | |
| MR POCKET FILLER |  | 2004 | 1 | Cut to size | |
| MR PIVOT SET |  | | 1 | | 4 x SS Screws for screwing into frame |
| MR DOOR KNOB |  | | 1 | | |
| MR GLAZING RUBBER |  | (9-mtrs) | 1 | To suit 6mm glass | |
| MR BOTTOM-SEAL |  | 700 | 1 | Cut to size | |
| MR CENTER-SEAL |  | 2000 | 2 | Cut to size | |
| MR END-SEAL |  | 1980 | 1 | Cut to size | |

MASTER RANGE

2 PANEL A (INLINE SHOWERS) (technical drawings)

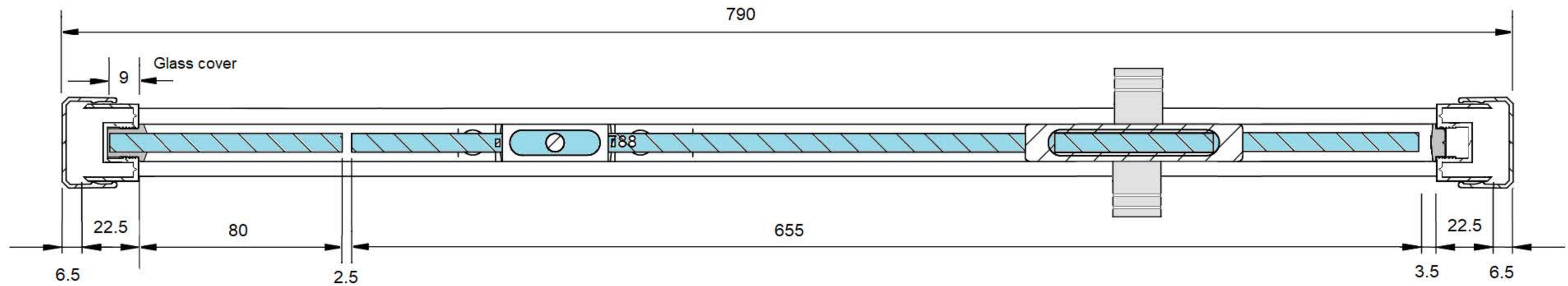
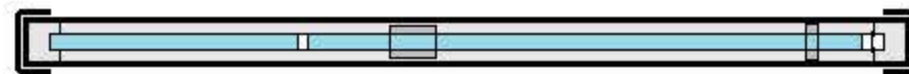
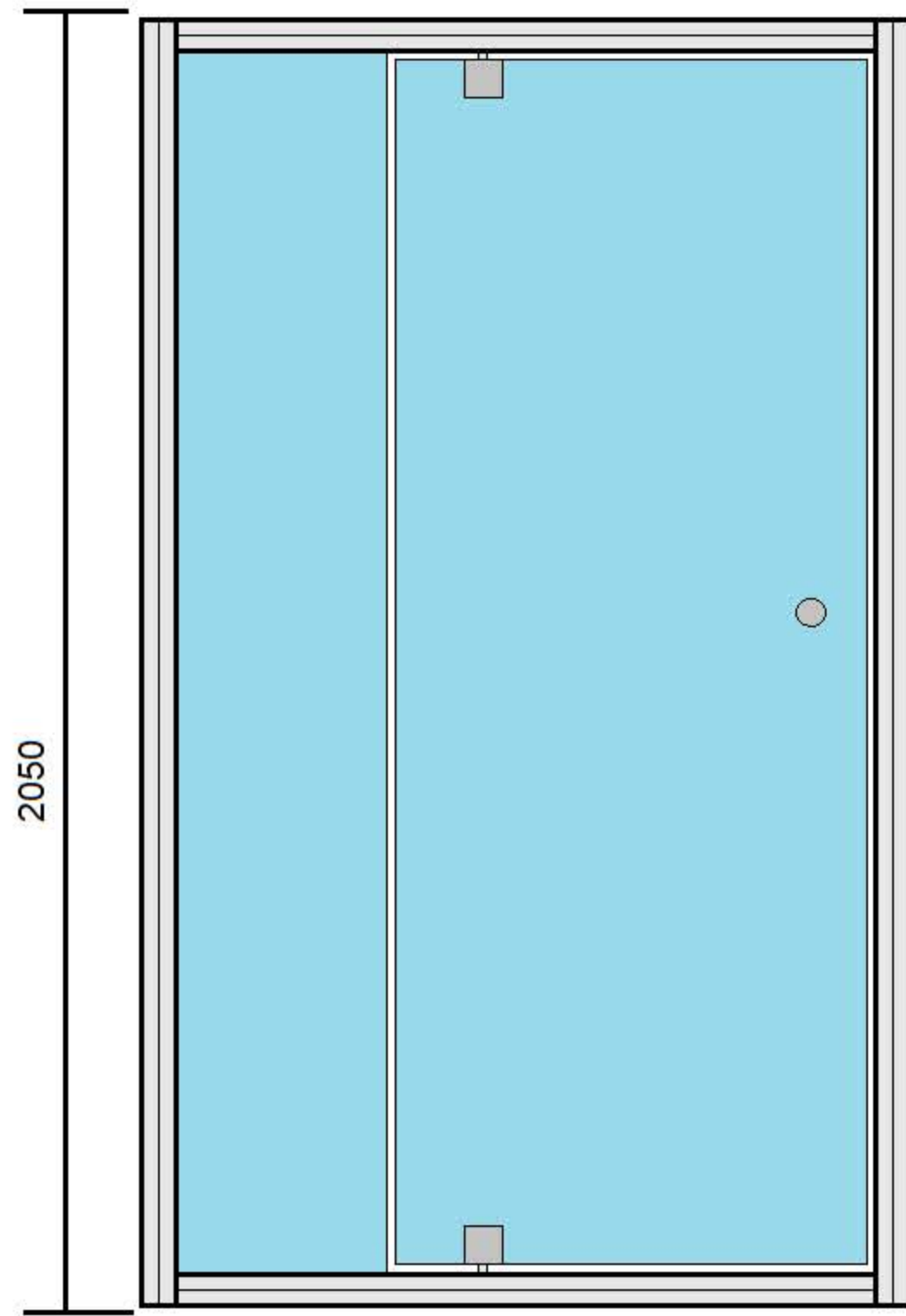

MASTER RANGE

2 PANEL B (INLINE SHOWERS) (technical drawings)

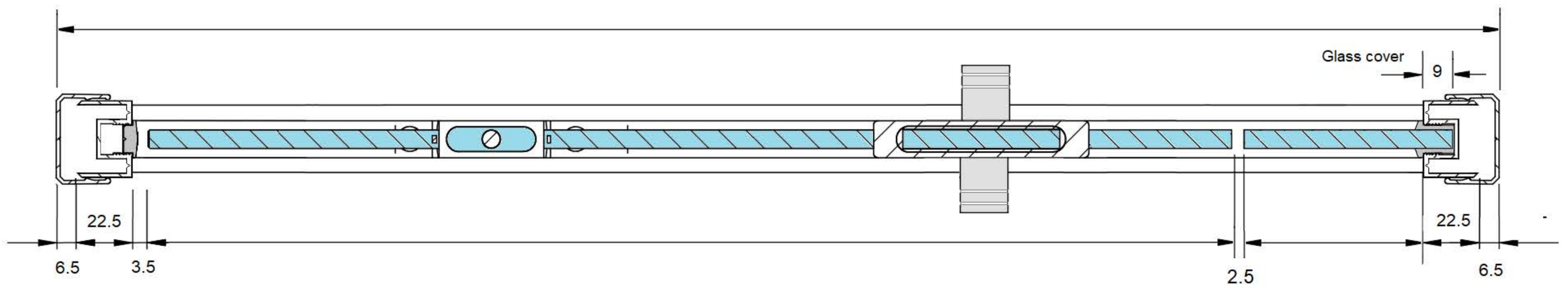
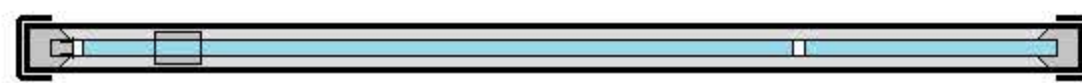
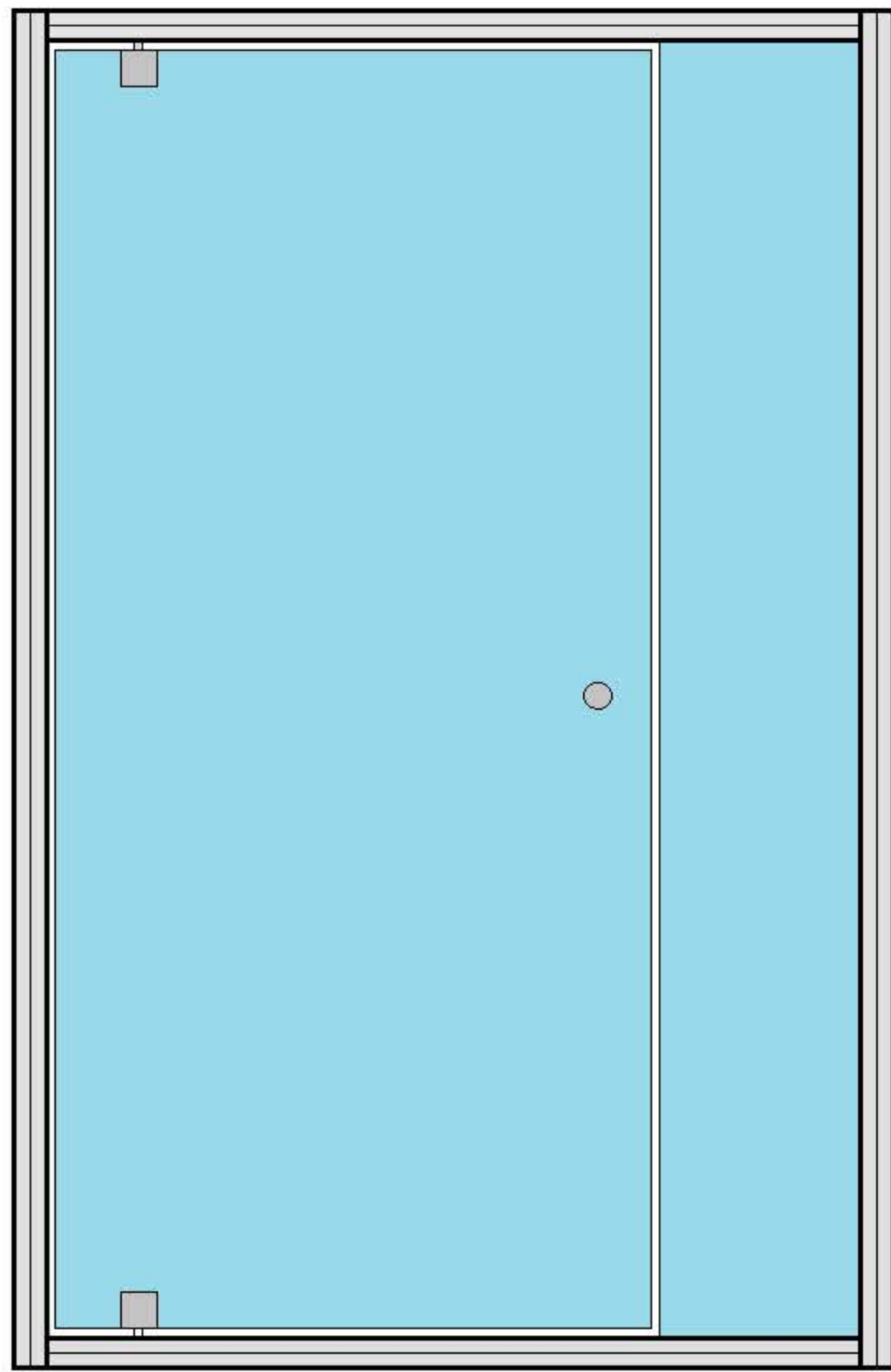

MASTER RANGE

3 PANEL (INLINE SHOWERS) (technical drawings)

