















MASTER RANGE : CORNER SHOWER KITS (H2050 W1600xW1200)

<u>PART LIST</u>		<u>LENGTH (in mm)</u>	<u>QTY</u>	<u>MANUFACTURING</u>	<u>SUPPLIED WITH</u>
MR FRAME		2050	2	Cut to size 2050mm Pre-Drilled top & bottom to suit top & bottom sill	
MR SILL		1600	2	Cut to size 1200mm	8 x SS Screws with Wall Plugs & screw head covers. 6 x pop riverts (color to match frames)
MR SILL		1200	2	Cut to size 1200mm	8 x SS Screws with Wall Plugs & screw head covers. 6 x pop riverts (color to match frames)
MR WALL CHANNEL		2050	2	Drill/Slot 3 holes in back side	6 x SS Screws with Wall Plugs & Screw head covers. 10 x pop riverts (color to match frames)
MR POCKET FILLER		700	2	Cut to size	
MR POCKET FILLER		2004	1	Cut to size	
MR CORNER JOINER			2		
MR CORNER JOINER			2		
MR PIVOT SET			1		4 x SS Screws for screwing into frame
MR DOOR KNOB			1		
MR GLAZING RUBBER		(12 mtrs)	1	To suit 6mm glass	
MR BOTTOM-SEAL		700	1	Cut to size	
MR CENTER-SEAL		2000	2	Cut to size	
MR CORNER SEAL		2000	1	Cut to size	
MR END-SEAL		1980	1	Cut to size	

MASTER RANGE

3 PANEL B (CORNER SHOWER) (technical drawings)

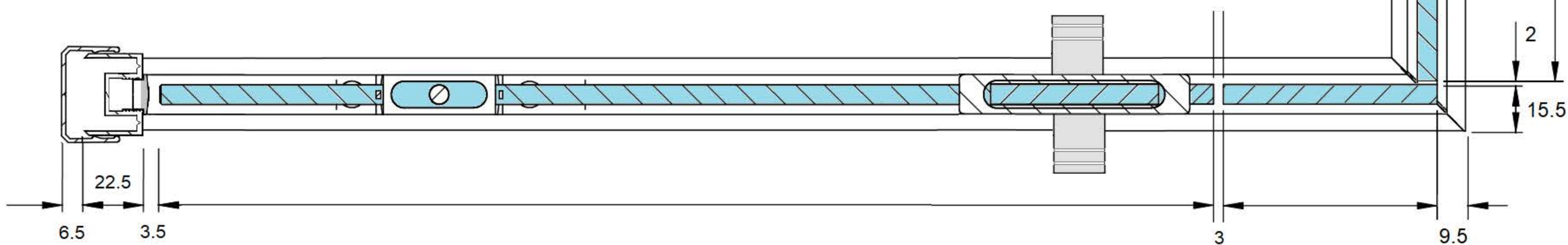
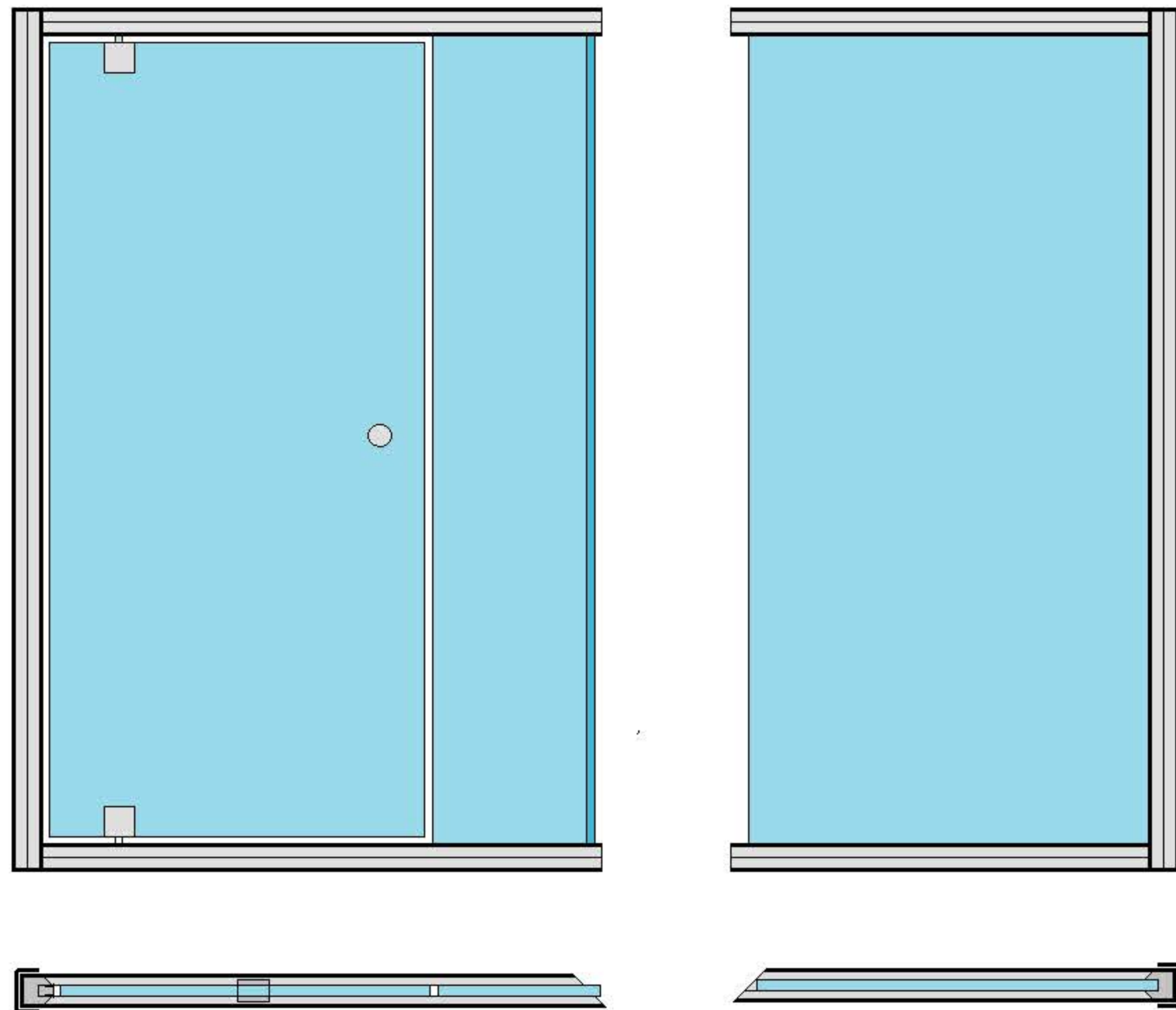

MASTER RANGE

3 PANEL A (CORNER SHOWER) (technical drawings)

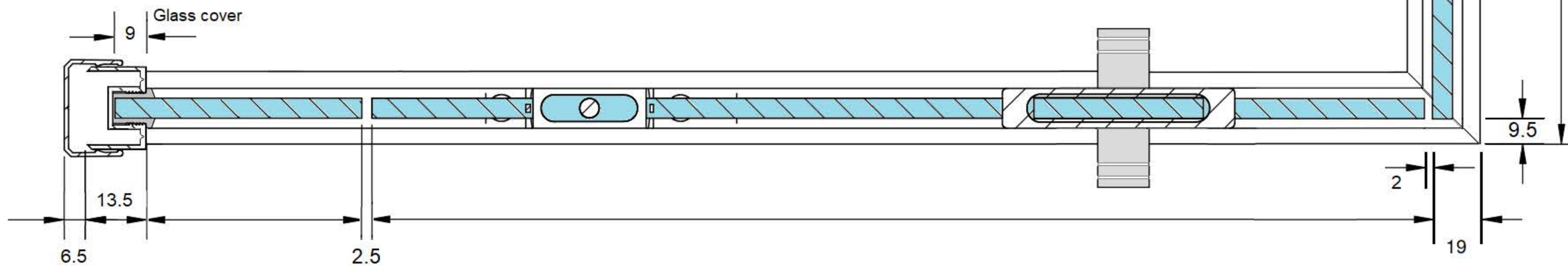
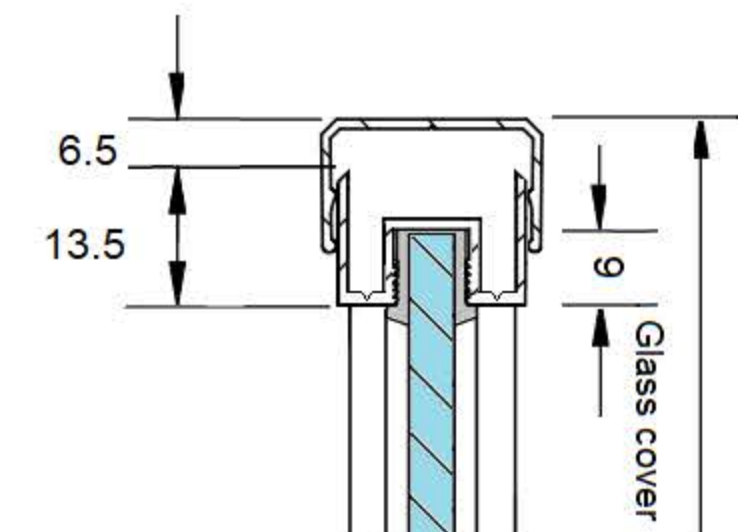
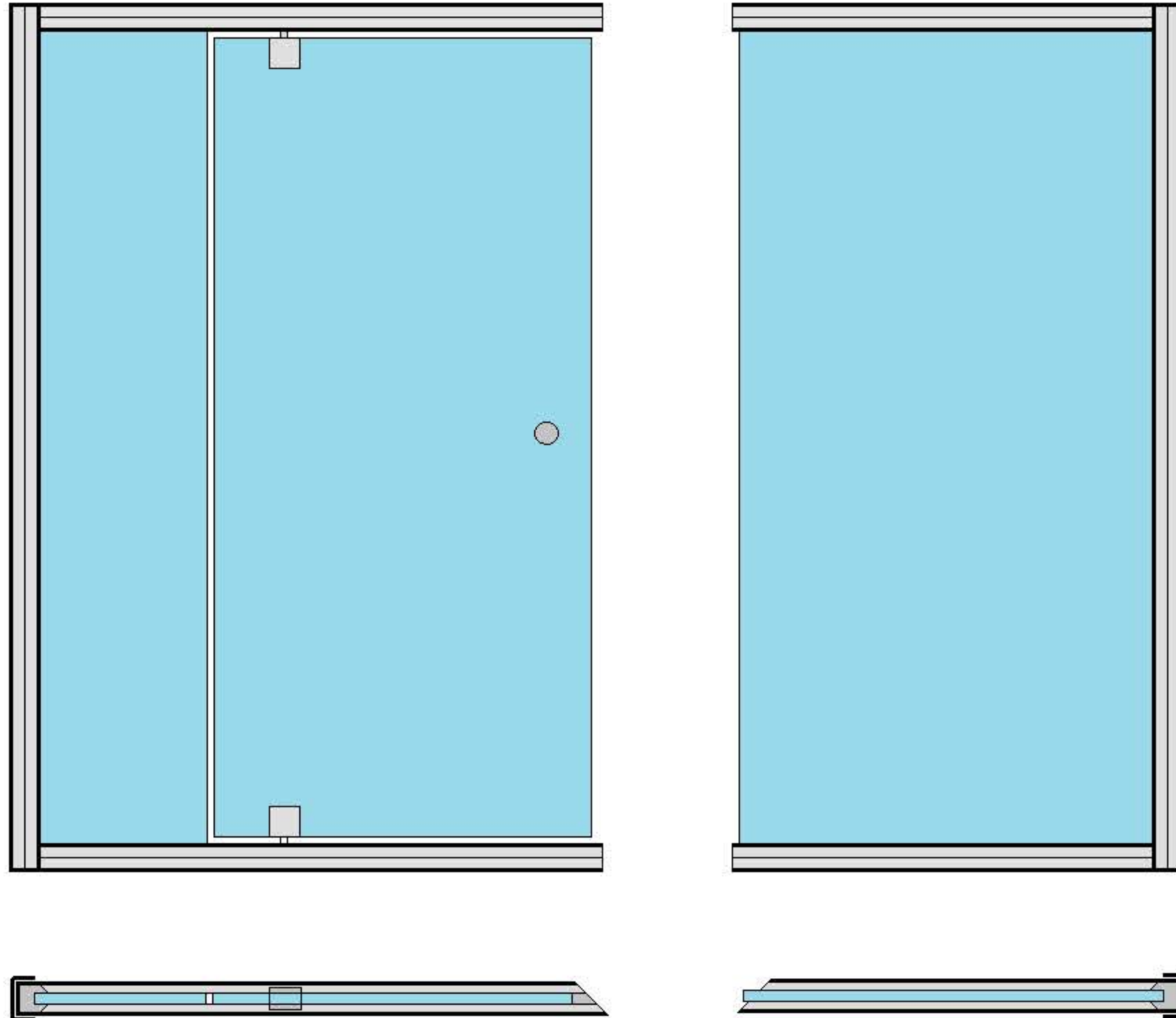

MASTER RANGE

4 PANEL (CORNER SHOWER) (technical drawings)

